



**HAL**  
open science

# Direct and Steering Tilt Robust Control of Narrow Vehicles

Lama Mourad, Fabien Claveau, Philippe Chevrel

► **To cite this version:**

Lama Mourad, Fabien Claveau, Philippe Chevrel. Direct and Steering Tilt Robust Control of Narrow Vehicles. IEEE Transactions on Intelligent Transportation Systems, 2014, 15 (3), pp.1206-1215. 10.1109/TITS.2013.2295684 . hal-00932688

**HAL Id: hal-00932688**

**<https://hal.science/hal-00932688>**

Submitted on 11 Apr 2016

**HAL** is a multi-disciplinary open access archive for the deposit and dissemination of scientific research documents, whether they are published or not. The documents may come from teaching and research institutions in France or abroad, or from public or private research centers.

L'archive ouverte pluridisciplinaire **HAL**, est destinée au dépôt et à la diffusion de documents scientifiques de niveau recherche, publiés ou non, émanant des établissements d'enseignement et de recherche français ou étrangers, des laboratoires publics ou privés.

# Direct and Steering Tilt Robust Control of Narrow Vehicles

Lama Mourad, Fabien Claveau, and *Philippe Chevrel*

**Abstract** — Narrow Tilting Vehicles (NTVs) are the convergence of a car and a motorcycle. They are expected to be the new generation of city cars considering their practical dimensions and lower energy consumption. However, due to their height to breadth ratio, in order to maintain lateral stability, NTVs should tilt when cornering. Unlike the motorcycle, where the driver tilts the vehicle himself, the tilting of an NTV should be automatic. Two tilting systems are available; Direct and Steering Tilt Control, the combined action of these two systems being certainly the key to improve considerably NTV dynamic performances. In this paper, multivariable control tools ( $H_2$  methodology) are used to design, in a systematic way, lateral assistance controllers driving DTC, STC or both DTC/STC systems. A three degrees of freedom model of the vehicle is used, as well as a model of the steering signal, leading to a two degrees of freedom low order controller with an efficient feedforward anticipative part. Taking advantage of all the available measurements on NTVs, the lateral acceleration is directly regulated. Finally, a gain-scheduling solution is provided to make the DTC, STC, and DTC/STC controllers robust to longitudinal speed variations.

**Index Terms** — Narrow Tilting Vehicle (NTV), Vehicle Dynamics, Robust Multivariable Control,  $H_2$  Control, 2 DoF Control, Gain-Scheduling

## I. INTRODUCTION

A new generation of cars is currently being studied which will be more practical and efficient in relation to traffic congestion and parking problems in urban areas. These cars are small narrow commuter vehicles, hence saving energy, and are approximately half as wide as a conventional car (less than 1 m), with the second passenger seated behind the driver in tandem. Considering their geometry, (approximately 2.5 m long, 1 m wide and 1.5 m high), these cars are characterized by a high centre of gravity, which makes roll stability an issue. To reduce this risk, they may have to lean into corners like two-wheeled vehicles. Some three- and four-wheel NTV projects have already been proposed by several companies. The Ford Gyron is one of the earliest prototypes while General

Motors developed the Lean Machine, with a manual lean system controlled by the driver. Mercedes-Benz stopped at the design stage of the F-300 Life Jet. More recently, Brink Dynamics developed the Carver, a three-wheeled car with a rotating body but a non-tilting rear engine, while the manufacturer Lumeneo proposed the Smera [1]. Lastly, Nissan revealed the Land Glider at the 2009 Tokyo Motor Show.

Two mechanical systems are available to tilt the vehicle [2]-[6]: Direct Tilt Control (DTC) and Steering Tilt Control (STC), see Fig. 1:

- the DTC system is based on a dedicated actuator mounted on the longitudinal axis of the NTV, providing a torque ( $M_t$ ) to tilt the vehicle.
- the STC actuator requires a Steer-by-Wire system: the steering angle ( $\delta_{driv}$ ) applied by the driver is modulated by the STC system ( $\delta_c$ ) to control the tilt angle using counter-steering. The tilting strategy is therefore directly inspired by the action of a bicycle or motorcycle rider.

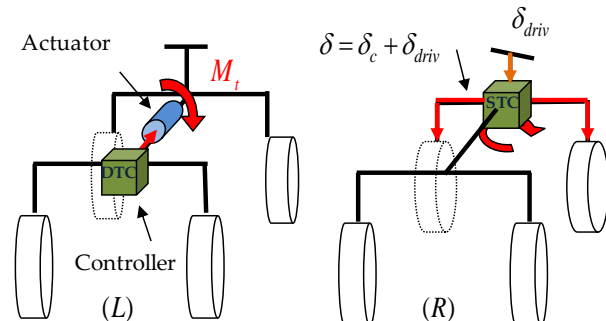

Fig. 1. Tilting actuators: DTC (left) and STC (right) systems

STC systems are not well suited for low longitudinal speeds (e.g. less than  $8 \text{ m.s}^{-1}$  [5]), demanding a large counter-steering to tilt the vehicle, which deviates it significantly from its trajectory. In contrast, the STC system may be more efficient than the DTC one at high speed, as a large torque is required by the DTC when entering a bend if the tilting torque occurs a little late. In that case, the main drawbacks of DTC can be energy consumption and discomfort at the beginning of a curve. To benefit from the complementary advantages of both systems, and their completeness at low and high speeds, several projects have involved the STC and DTC systems working together [5]-[9]. To the authors' knowledge, all these solutions are based on hybrid or switched strategies: below a given speed the DTC system is actuated, and above that speed the STC system takes control. With such an approach, the designer has to solve several problems, [4]-[6],[10],[11]: for

Manuscript received May 22, 2103; revised September 17, 2013; accepted December 05, 2013.

The Authors are with the LUNAM, the Institut Mines-Télécom (Ecole des Mines de Nantes), and the laboratory IRCCyN – UMR CNRS 6597.

Ecole des Mines de Nantes, La Chantrerie, 4, Rue Alfred Kastler, BP 20722, 44307 NANTES Cedex 3 (e-mail: lama.mourad@mines-nantes.fr, fabien.claveau@mines-nantes.fr, philippe.chevrel@mines-nantes.fr)

example, the switch from the STC to the DTC strategy should not occur during a counter-steering maneuver. Furthermore, STC and DTC strategies do not lead to the same static errors, leading to discontinuous behavior if a DTC/STC switch occurs during a constant radius bend. To avoid finding heuristics as switching strategies, Roberston *et al.* [12] proposed a multivariable controller driving both STC and DTC systems in a cooperative manner. It is based on a DTC feedback loop coupled with an STC open-loop, with the several control elements being designed independently. Improvements in NTV performances are strongly linked to the success of the combined action of DTC and STC systems. In this perspective, taking advantage of multivariable control tools could be of interest in order to design, in a systematic way, lateral assistance controllers driving DTC, STC or both DTC/STC systems. This is the main contribution of this paper. Based on (linear) robust control tools ( $H_2$  criterion), the proposed solution leads to multivariable controllers exploiting the several measurements available in such vehicles to drive only the DTC or the STC system, or both in an easily tunable degree of sharing. The controller solutions of the problem, which are static or of low order, take advantage of the steering signal to anticipate the tilting of the vehicle, and regulate directly its lateral acceleration [11]. A gain-scheduling solution is also proposed to make the controllers robust to longitudinal velocity variations.

The paper is organized as follows: Section 2 presents the NTV non-linear and linear 3 DoF models and formulates the lateral dynamics control problem; Section 3 describes the multivariable controller design methodology proposed, leading to a low order controller. The methodology is applied to the NTV system in Section 4, leading to LTI controllers. The LPV controller is described in Section 5 and the results obtained in simulation on the non-linear model are shown in Section 6. The conclusion and perspectives are presented in Section 7.

## II. NTV MODELS AND LATERAL STABILITY PROBLEMS

### A. 3 DoF Non-Linear Model of the Lateral Dynamics

The first model (and control laws) was proposed in [5], [10], considering only the dynamics of the tilting angle (SISO model), eventually coupled with the longitudinal dynamics in [6]. In the ‘‘Clever’’ Project at Bath University, J. Berote put forward in [13] a five DoF (Degrees of Freedom) non-linear model, including the dynamics of the hydraulic actuators. This was used as a simulation model in [12]. A non-linear model based on four bodies and six DoF was proposed in [14] to model a prototype equipped with an STC actuator. In [15], the model of a four-wheel NTV prototype was developed (11 bodies, obtained due to the Lagrangian formulation). To the authors’ knowledge, the most complete studies on the modeling (and design of lateral assistance systems) have been carried out by the University of Minnesota [2]-[4],[7]-[9]. Using Newton’s laws, they proposed several non-linear and linear models that can be used as simulation or design tools. A simple three DoF bicycle model, put forward to study the

lateral dynamics of NTV in particular, will be used in this paper. The model and the underlying assumptions were revisited in [16],[17] using a systematic model design borrowed from robotics. These assumptions are: 1- the vehicle is considered a mass point at its centre of gravity; 2- vertical reaction forces on the right and left wheels are considered identical; 3- gyroscopic effects due to the rotation of the wheels and road bank angle are neglected; 4- tire forces are simplified, considering small angle approximations; 5- many mechanical parts that would have an impact on the vehicle’s dynamics are not represented (*e.g.* dampers). Nevertheless, this simplified model can still be used for control, as long as the control law has some robustness. The three degrees of freedom are the tilt angle  $\theta$ , the yaw angle  $\psi$  and the lateral position  $y$  (Fig. 2).

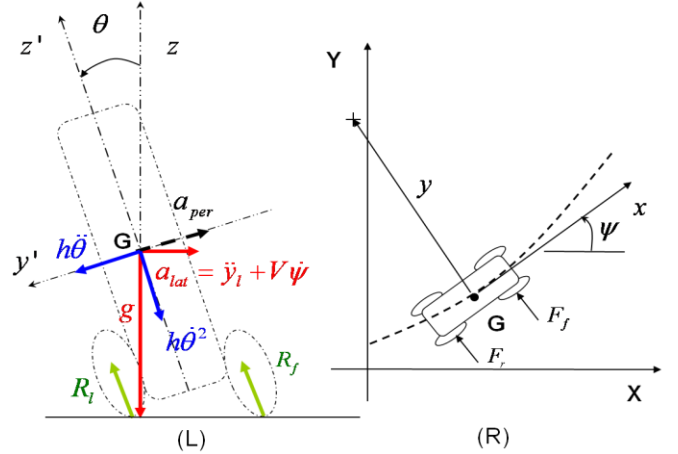

Fig. 2. Three degrees of freedom of the tilting vehicle: (L) front view and (R) top view; and accelerations perceived at its centre of gravity (L)

The reference  $(xyz)$  is attached to the centre of gravity of the vehicle  $G$ , with  $(xy)$  the horizontal plane, while  $(x'y'z')$  is also attached to the centre of gravity, but leans with the vehicle, *i.e.* it is attached to the chassis. The lateral position  $y$  is defined as the distance between the vehicle’s centre of gravity and its instantaneous centre of rotation, while the yaw angle  $\psi$  is measured with respect to the global axis  $X$ , and  $\theta$  is the angle between the cabin’s upright position and its actual position. Finally,  $F_f$  and  $F_r$  are the front and rear lateral forces, respectively, applied on the tires in the  $(XY)$  plane. All this leads to a first non-linear model:

$$\begin{cases} m\ddot{y} + m\dot{\psi}V + mh\ddot{\theta}\cos\theta - mh\dot{\theta}^2\sin\theta = F_f + F_r \\ I_x\ddot{\theta} = mgh\sin\theta - mh^2\ddot{\theta}\sin^2\theta - mh\dot{\theta}^2\cos\theta\sin\theta \\ \quad - (F_f + F_r)h\cos\theta + M_t \\ I_z\ddot{\psi} = l_f F_f - l_r F_r \end{cases} \quad (1)$$

$$F_f = 2C_f\left(\delta - \frac{\dot{y}_l + l_f\dot{\psi}}{V_x}\right) + 2\lambda_f\theta, \quad F_r = 2C_r\left(-\frac{\dot{y}_l + l_r\dot{\psi}}{V_x}\right) + 2\lambda_r\theta.$$

The inputs of this model are the steering angle  $\delta$  and the torque  $M_t$  if a DTC system is considered, while the state vector is  $[\dot{y} \ \dot{\psi} \ \theta \ \dot{\theta}]^T$ . All signals and parameters in (1) are

summarized in Table 1.

Table 1. Parameters of The 3 DoF Model: See [2],[18] For Numerical Values

$y, \dot{y}$	lateral position and speed of the vehicle	$m$	total mass
$\psi, \dot{\psi}$	yaw angle and speed	$V$	longitudinal speed of the vehicle
$\theta, \dot{\theta}$	tilt angle and speed	$h$	position of the center of gravity $G$ on the $z'$ axis
$a_{per}$	lateral perceived acceleration at the center of gravity $G$	$I_z$	vehicle yaw moment of inertia
$M_t$	tilting torque provided by the DTC actuator	$I_x$	vehicle roll moment of inertia
$\delta$	steering angle of the front wheels	$l_f$	distance from center of gravity to front axle
$\delta_{driv}$	steering angle provided by the driver	$l_r$	distance from center of gravity to rear axle
$\delta_c$	steering angle modulation generated by the STC actuator	$C_f$	front cornering stiffness
$F_f$	front lateral force	$C_r$	rear cornering stiffness
$F_r$	rear lateral force	$g$	gravitational constant

### B. 3 DoF Linear (LPV) Model of the Lateral Dynamics

The model (1) is non-linear. It is of interest to obtain a linear version, mainly to have access to the efficient tools available within robust and optimal linear control theory. The validity of the linearized model around  $\theta = 0$  (model also proposed in [2]) was studied in [11], also during cornering, although  $\theta = 0$  is not the equilibrium point in that case. The Linear Parameter Variant (LPV) model considered is parameterized by the longitudinal speed,  $V$ , of the vehicle:

$$\begin{cases} \dot{x}(t) = A_m(V)x(t) + B_m u(t) \\ y(t) = C_m x(t) + D_m u(t) \end{cases} \quad (2)$$

with  $x^T = [\dot{y} \quad \dot{\psi} \quad \theta \quad \dot{\theta}]^T \in \mathbb{R}^4$ ,  $u^T = [\delta \quad M_t]^T \in \mathbb{R}^2$ ,

$$A_m(V) = \begin{bmatrix} \frac{1}{V}(-\frac{a}{m} - \frac{h^2 a}{I_x}) & \frac{1}{V}(-\frac{b}{m} - \frac{h^2 b}{I_x}) - V & 2(\lambda_f + \lambda_r)(\frac{1}{m} + \frac{h^2}{I_x}) - \frac{mgh^2}{I_x} & 0 \\ \frac{1}{V} \frac{b}{I_z} & -\frac{1}{V} \frac{2(C_f l_f^2 + C_r l_r^2)}{I_z} & \frac{2(\lambda_f l_f - \lambda_r l_r)}{I_z} & 0 \\ 0 & 0 & 0 & 1 \\ \frac{1}{V} \frac{h a}{I_x} & \frac{1}{V} \frac{h b}{I_x} & \frac{mgh - 2h(\lambda_f + \lambda_r)}{I_x} & 0 \end{bmatrix}$$

$$B = [B_\delta \quad B_{M_t}], \quad B_\delta = \begin{bmatrix} 2C_f(\frac{1}{m} + \frac{h^2}{I_x}) & \frac{2C_f l_f}{I_z} & 0 & -\frac{2C_f h}{I_x} \end{bmatrix}^T,$$

$$B_{M_t} = \begin{bmatrix} -\frac{h}{I_x} & 0 & 0 & \frac{1}{I_x} \end{bmatrix}^T, \quad a = 2(C_f + C_r), \quad b = 2(l_f C_f - l_r C_r)$$

The measured signals in  $y(t) \in \mathbb{R}^p$  and the associated  $C$  and  $D$  matrices will be defined in section IV.A. The model (2) becomes an LTI (Linear Time Invariant) model when considering a constant longitudinal velocity  $V$ .

### C. Control of the Lateral Acceleration $a_{per}$

As already mentioned, the objective of the automatic tilting assistance is to ensure the lateral stability of the NTV faced with lateral acceleration when cornering. In particular, the lateral acceleration at the center of gravity is of importance.

*Definition 1: Perceived acceleration  $a_{per}$*

$a_{per}$  denotes the resultant acceleration at the center of gravity  $G$ , along the axis ( $y'$ ) (cf. Fig. 2-L), i.e. perpendicular to the chassis of the vehicle. It is linked to other variables by:

$$a_{per} = a_{lat} \cos \theta + h\ddot{\theta} - g \sin \theta = (\ddot{y} + V\dot{\psi}) \cos \theta + h\ddot{\theta} - g \sin \theta \quad (3)$$

*Remarks*

The terminology "perceived" (or measured) acceleration was introduced in [2]. This would be the acceleration measured by an accelerometer positioned at the center of gravity whose lateral axis is in the lateral vehicle direction, and also the lateral acceleration perceived by the driver in the cabin of the vehicle, impacting the comfort. The proof leading to the expression of  $a_{per}$  can be found in [2], [11].

Fundamentally, the lateral stability of the NTV is ensured if

$$a_{per} = (\ddot{y} + V\dot{\psi}) \cos \theta + h\ddot{\theta} - g \sin \theta = 0. \quad (4)$$

In this paper, as in [18]-[20], the direct regulation of  $a_{per}$  is considered, whereas the literature classically reformulates the lateral control problem as an angular position tracking problem, regulating the tilting angle  $\theta$  around the reference angle  $\theta_{ref}$ , estimated on line by inverting equation (4) (with more or fewer approximations) [4]-[10],[13]-[15]. The advantage of the latter strategy is that a well known SISO controller, such as the PD controller, can be used, with a simple design model (see e.g. [5],[10]). Furthermore, it seems natural to take into account constraints on the tilting angle and velocity, although alternatives are possible. However, it has several drawbacks:

- the tilting angle reference is not known *a priori*, which requires on line approximation, typically  $\theta_{ref} = \tan^{-1}(V\dot{\psi}/g)$ , hence it does not lead exactly to the targeted equilibrium point. With a DTC system, this will induce excess energy consumption, as the actuator will have to produce a residual torque. Delays may even worsen the result.

- although the signal  $\theta_{ref}$  is considered an exogenous signal, e.g. in [5],[10], it is not. It is based on the vehicle state, thus materializing an implicit feedback loop which is potentially destabilizing.

### D. Available Measurements

Practically, tilting cars generally include a tilt angle sensor and an Inertial Measurement Unit (IMU), which provide the state values  $\theta$ ,  $\dot{\theta}$  and  $\dot{\psi}$ , but not  $\dot{y}$ . The IMU will also give the perceived acceleration  $a_{per}$  (see previous subsection). Lastly, as in conventional vehicles, the steering angle  $\delta$  and its derivative  $\dot{\delta}$  can be measured.

### E. Formulation of the Control Objectives

To sum up and complete sub-section C, the tilting controller of an NTV should meet the following requirements:

1. Regulation of the lateral acceleration  $a_{per}$  or even its integral  $a_{per}^I$  ( $\dot{a}_{per}^I = a_{per}$ ) to avoid any static error during long curves (see [18] for a study on the impact of different frequency weighting functions on  $a_{per}$  and the energy consumption of the DTC actuator).
2. Minimization of the transition behavior of the actuators, especially for the DTC system, to improve energy consumption and also comfort.
3. Concerning the STC system, if any, its action should be as minimal as possible in order to respect the trajectory desired by the driver.
4. Robustness to variations in the longitudinal velocity, but also more generally to variations in important dynamic parameters of the vehicle such as its mass.
5. Easy to implement controller to match the computing capacity of the embedded computer.

To reach such objectives, a multivariable 2 DoF controller is proposed, including a feedforward part taking advantage of the steering signal  $\delta$  and its derivative to anticipate. The control objectives will be taken into consideration through an  $H_2$  criterion [21]. The use of the  $H_2$  framework is motivated by the possibility of designing, in a systematic way with few tuning parameters, an optimal multivariable controller which will drive the STC and DTC systems simultaneously.

## III. $H_2$ STRUCTURED OUTPUT FEEDBACK SYNTHESIS

### A. Design Methodology and Associated Standard Model

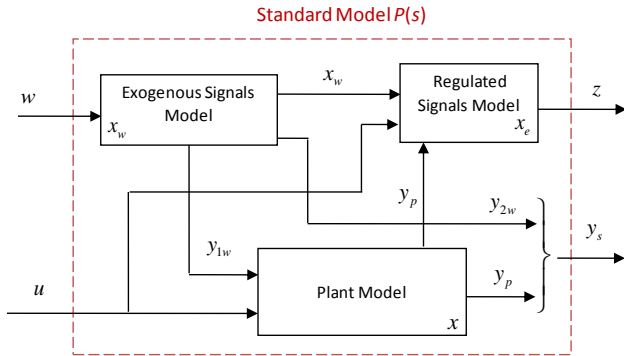

Fig. 3. The structured generic standard model

The design methodology proposed here provides a well-posed  $H_2$  standard problem in a systematic way, taking into consideration the control objectives previously presented. It is compatible with every controller considered, using DTC, STC, or both DTC/STC actuators. The model underlying the  $H_2$  problem is structured in three generic blocks (cf. Fig. 3):

- The plant model ( $S$ ): with the state vector  $x \in \mathbb{R}^n$ , the control input signals  $u \in \mathbb{R}^m$ , the exogenous input signals (typically disturbances)  $y_{1w} \in \mathbb{R}^{p_{1w}}$ , and the measured output signals  $y_p \in \mathbb{R}^p$ .

$$(S) \begin{cases} \dot{x} = Ax + B_w y_{1w} + B_u u \\ y_p = Cx + D_w y_{1w} + D_u u \end{cases} \quad (5)$$

- The model of the environment of the plant ( $S_{rd}$ ), i.e. the model of the exogenous signals: this model aggregates *a priori* knowledge about exogenous signals such as the disturbances (state vector  $x_d$ ) or the references (state vector  $x_r$ ), with  $x_w = [x_r \ x_d]^T \in \mathbb{R}^{n_w}$ ,  $y_{2w} \in \mathbb{R}^{p_{2w}}$  potentially different from signals  $y_{1w}$ ,  $w \in \mathbb{R}^{n_w}$  being irreducible.

$$(S_{rd}) \begin{cases} \dot{x}_w = A_w x_w + B_w w \\ y_{1w} = C_{1w} x_w \\ y_{2w} = C_{2w} x_w \end{cases} \quad (6)$$

- The model of the signals to be regulated ( $S_{rs}$ ): where the signals to be controlled are built (typically error signals between one signal and its reference). Both static and dynamic weighting functions (filters) can be used. It involves the error signals  $e \in \mathbb{R}^{p_e}$ , split into the output deviation  $e_y$  and the input deviation  $e_u$ . These signals have to be regulated i.e. they must reach zero asymptotically. The initial persistent disturbance rejection (or reference tracking) problem must therefore be converted to a regulation one. If the reference signals for the outputs are “natural” most of the time, the whole reference trajectory has to be determined. One solution is to invert the plant model. The one used here makes use of the methodology proposed in [22],[23] (involving Sylvester equations).

$$(S_{rs}) \begin{cases} \dot{x}_e = A_e x_e + \begin{bmatrix} B_{ex} & B_{ew} \end{bmatrix} \begin{bmatrix} y_p \\ x_w \end{bmatrix} + B_{eu} u \\ e = \begin{bmatrix} e_y \\ e_u \end{bmatrix} = \begin{bmatrix} C_{ey} \\ C_{eu} \\ c_e \end{bmatrix} x_e + \begin{bmatrix} D_{e11} & D_{e12} \\ D_{e21} & D_{e22} \\ D_{ex} & D_{ew} \end{bmatrix} \begin{bmatrix} y_p \\ x_w \end{bmatrix} + \begin{bmatrix} D_{eu1} \\ D_{eu2} \\ D_{eu} \end{bmatrix} u \quad (7) \\ z = Q_0 \frac{1}{s} e \end{cases}$$

$x_e \in \mathbb{R}^{n_e}$ ,  $z \in \mathbb{R}^{p_z}$ ,  $Q_0 \in \mathbb{R}^{p_z \times p_e}$  is a static weighting matrix playing the role of tuning parameters.

Combining models (5) to (7) leads to the final standard model  $P(s)$ :

$$P(s) \begin{cases} \dot{x}^s = A^s x^s + B_1^s w + B_2^s u \\ z = C_1^s x^s + D_{12}^s u \Leftrightarrow \\ y_s = C_2^s x^s + D_{22}^s u \end{cases}$$

$$P(s) \begin{cases} \begin{bmatrix} \dot{x} \\ \dot{x}_e \\ \dot{x}_w \end{bmatrix} = \begin{bmatrix} A & 0 & B_w C_{1w} \\ B_{ex} & A_e & B_{ew} \\ 0 & 0 & A_w \end{bmatrix} \begin{bmatrix} x \\ x_e \\ x_w \end{bmatrix} + \begin{bmatrix} 0 \\ 0 \\ B_w \end{bmatrix} w + \begin{bmatrix} B_u \\ B_{eu} \\ 0 \end{bmatrix} u \\ z = Q_0^{\frac{1}{2}} \begin{bmatrix} e_y \\ e_u \end{bmatrix} = Q_0^{\frac{1}{2}} \left( \begin{bmatrix} D_{ex} & C_e & D_{ew} \end{bmatrix} \begin{bmatrix} y_p \\ x_e \\ x_w \end{bmatrix} + \begin{bmatrix} D_{eu} \end{bmatrix} u \right) \\ y_s = \begin{bmatrix} y_p \\ y_{2w} \end{bmatrix} = \begin{bmatrix} C & 0 & D_w C_{1w} \\ 0 & 0 & C_{2w} \end{bmatrix} \begin{bmatrix} x \\ x_e \\ x_w \end{bmatrix} + \begin{bmatrix} D_u \\ 0 \end{bmatrix} u \end{cases} \quad (8)$$

### B. Low Complexity Controller Synthesis

As stated before in section II.E, the controller to be designed must be of low complexity to facilitate its implementation and readability. More precisely, we constrained the controller to be of the form:

$$u = -K_y y_s - K_e e_y = \underbrace{-K_p y_p - K_e e_y}_{\text{feedback}} - \underbrace{K_w y_{2w}}_{\text{feedforward}} \quad (9)$$

with  $K_y \in \mathbb{R}^{m \times (p+p_{2w})}$ ,  $K_e \in \mathbb{R}^{m \times p_e}$ ,  $K_p \in \mathbb{R}^{m \times p}$ ,  $K_w \in \mathbb{R}^{m \times p_{2w}}$  being static gains. The resulting controller  $K^{st}(s)$  is of low order as the only dynamics involved are in fact a copy of the dynamics of the ‘‘Regulated Signals Model’’ in Fig. 3.

### C. Structured $H_2$ Problem

Finally, the control problem to be solved can be summarized as follows.

#### Problem $P_1$ : Structured $H_2$ problem

Find the  $H_2$  structured controller  $K^{st}(s)$  defined by equation (9) that:

- minimizes  $\|F_l(P(s), K(s))\|_2^2 = \|z(t)\|_2^2$ ,
- internally stabilizes the system (S) (5).

Only the internal stability of the system (and not of the whole standard model  $P(s)$ ) is required. The assumptions and the solution of such a problem can be found in [24]-[26], in the unconstrained case (neither on the structure nor the order of the desired controller).

### D. Design Tools

Such a constrained control problem cannot be solved with the classical results of  $H_2 / H_\infty$  theory [21], as here the designer has to deal with a non-convex optimization problem. Solutions can be found in the literature [27], [28] even implemented in Matlab<sup>®</sup> toolboxes, such as Hifoo [28], [29]. However, they require non-convex optimization. On the other hand, the analytical solution to problem  $P_1$  is known if the whole state of the standard model  $P(s)$  is known, that is to say:

$$y_s = \begin{bmatrix} x^T & x_e^T & x_w^T \end{bmatrix}^T. \quad (10)$$

The state feedback  $H_2$ -LQ problem (cf. (9) with  $y_p = x$ ,  $e_y = x_e$ ,  $y_{2w} = x_w$ ,  $u = -K_{opt} y_s$ ) is derived by solving a Riccati equation [21]. The point is that the equality (10) does not match the reality of tilting vehicle control. However, we will show in section IV.B that it is possible to reconstruct the whole plant state  $x$  thanks to the available measurements, by using a static estimator.

## IV. APPLICATION TO NTV: DESIGN OF AN LTI CONTROLLER

The proposed methodology is applied to design a lateral assistance for an NTV, assuming both STC and DTC systems are available. It will be shown that a controller can be designed using only the DTC or STC systems, or both, by simply changing the weighting coefficients in matrix  $Q_o$  (see (8)).

### A. Definition of the Standard Model $P(s)$

#### Plant model

The plant model (5) is derived from the linear model (2), considering a frozen value of the longitudinal speed  $V$  (LTI model). The SDTC system action  $\delta_c$  modulates the driver steering action  $\delta_{driv}$ , leading to the steering of the wheels  $\delta$  (no steering gear ratio is considered here):

$$\delta = \delta_{driv} + \delta_c. \quad (11)$$

$\delta_c$  is therefore a control signal, and  $\delta_{driv}$  an exogenous signal in (5). The measured signals (see section II.D) are

$$y_p = \begin{bmatrix} \dot{\psi} & \theta & \dot{\theta} & a_{per} \end{bmatrix}^T, \quad (12)$$

as illustrated in Fig. 4. Deriving from (4) the linearized relationship between  $a_{per}$  and other signals leads to:

$$\begin{aligned} a_{per}^{lin} &= \ddot{y} + V\dot{\psi} + h\ddot{\theta} - g\theta \\ \Leftrightarrow a_{per}^{lin} &= \underbrace{\begin{bmatrix} 0 & V & -g & 0 \end{bmatrix}}_{G_1} x + \underbrace{\begin{bmatrix} 1 & 0 & 0 & h \end{bmatrix}}_{G_2} \dot{x} \end{aligned} \quad (13)$$

$$\Leftrightarrow a_{per}^{lin} = G_1 x + G_2 (Ax + B_\delta \delta + B_{M_t} M_t) = Gx + H_\delta \delta + H_{M_t} M_t$$

Finally, the output equation in (5) is:

$$y_p = \underbrace{\begin{bmatrix} 0 & 1 & 0 & 0 \\ 0 & 0 & 1 & 0 \\ 0 & 0 & 0 & 1 \end{bmatrix}}_{C_m} x + \underbrace{\begin{bmatrix} 0 \\ 0 \\ 0 \end{bmatrix}}_{D_\delta} \delta + \underbrace{\begin{bmatrix} 0 \\ 0 \\ 0 \end{bmatrix}}_{D_{M_t}} M_t. \quad (14)$$

To sum up, the plant model included in the standard model  $P(s)$  is defined by:

- the input signals  $u = \begin{bmatrix} M_t & \delta_c \end{bmatrix}^T$ , the outputs  $y_p$  (14) and the (measured) exogenous input signal  $y_{1w} = \delta_{driv}$ ,

$$\begin{aligned}
 & \text{- matrices } A = A_m, \quad B_w = B_\delta, \quad B_u = \begin{bmatrix} B_\delta & B_{M_t} \end{bmatrix}^T, \quad C = C_m, \\
 & \quad D_w = D_\delta, \quad D_u = \begin{bmatrix} D_\delta & D_{M_t} \end{bmatrix}^T.
 \end{aligned}$$

### Exogenous signals model

There is no reference signal as the control objective is to regulate the lateral acceleration  $a_{per}$  to zero. However, considering a model of the driver steering angle  $\delta_{driv}$  is very useful, as shown in [20], in order to forecast a curved trajectory. Let us consider for  $\delta_{driv}$  the second order model:

$$\begin{cases} \begin{bmatrix} \dot{\delta}_{driv} \\ \ddot{\delta}_{driv} \end{bmatrix} = \begin{bmatrix} 0 & 1 \\ -\alpha_1\alpha_2 & -(\alpha_1 + \alpha_2) \end{bmatrix} \begin{bmatrix} \delta_{driv} \\ \dot{\delta}_{driv} \end{bmatrix} + \begin{bmatrix} x_{w0\_1} \\ x_{w0\_2} \end{bmatrix} \\ \dot{x}_w \\ y_{1w} = \begin{bmatrix} 1 & 0 \end{bmatrix} \begin{bmatrix} \delta \\ \dot{\delta} \end{bmatrix} = \delta_{driv} \\ y_{2w} = \begin{bmatrix} 1 & 0 \\ 0 & 1 \end{bmatrix} \begin{bmatrix} \delta_{driv} \\ \dot{\delta}_{driv} \end{bmatrix} = \begin{bmatrix} \delta_{driv} \\ \dot{\delta}_{driv} \end{bmatrix} \end{cases} \quad (15)$$

with  $w$  an impulse signal. Starting from an arbitrary initial condition  $x_{w0}^T = [x_{w0\_1} \quad x_{w0\_2}]$ ,  $\alpha_1$  and  $\alpha_2$  parameterize the steering signal and define the exogenous model (6). Model (15) is the simplest information that can be provided about driver behavior. It cannot really be considered a driver model as it does not react to road or vehicle stimuli. However, such minimal information still leads to good performances [20].

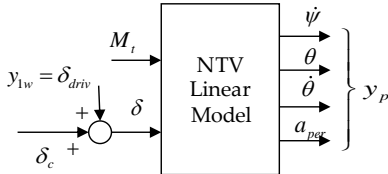

Fig. 4. The plant model inputs and outputs

### Regulated signals model (cf. (7) & Fig. 3)

According to the control objectives in section II.E, the regulated signals and associated references chosen are:

1. the integrated value of the lateral acceleration  $a_{per}$ ,  $a_{per}^I$ :

with a null reference signal,

2. the two control inputs  $\delta_c$  and  $M_t$ : their reference signal can be found from the results in [22],  $u_{ref} = -F_a x_w$ .

All this leads to the following system ( $S_{rs}$ ) (7):

$$\begin{cases} \dot{x}_e = a_{per}^I = [0]x_e + [D_{e11} \quad 0] \begin{bmatrix} y_p \\ x_w \end{bmatrix} + [0]u \\ e = \begin{bmatrix} e_y \\ e_u \end{bmatrix} = \begin{bmatrix} a_{per}^I \\ \delta_c \\ M_t \end{bmatrix} = \begin{bmatrix} 1 \\ 0 \\ 0 \end{bmatrix} x_e + \begin{bmatrix} 0 & 0 \\ 0 & F_a \end{bmatrix} \begin{bmatrix} y_p \\ x_w \end{bmatrix} + \begin{bmatrix} 0 & 0 \\ 1 & 0 \\ 0 & 1 \end{bmatrix} u \\ z = Q_0^{\frac{1}{2}} e = Q_0^{\frac{1}{2}} \begin{bmatrix} a_{per}^I \\ \delta_c \\ M_t \end{bmatrix}^T \end{cases} \quad (16)$$

with  $Q_0 = \text{diag}(Q, R_1, R_2)$ .  $Q, R_1, R_2$  are scalar values. The choice of  $R_1$  and  $R_2$  enables the designer to choose between DTC, STC or SDTC strategies (see section VI.A).

The standard model  $P(s)$  (8) is now completely defined. Problem  $P_1$  can be solved to find the structured  $H_2$  controller  $K^{st}(s)$ . As suggested in section III.D, in this paper the NTV model has a specific interdependency between its states, outputs and inputs, which enables it to be solved without resorting to non-convex optimization.

### B. Design of the $H_2$ Structured Controller $K^{st}(s)$

*Result R1:*

The state signal  $\dot{y}$  can be estimated from the measured signals (12)  $y_p = [\dot{\psi} \quad \theta \quad \dot{\theta} \quad a_{per}]^T$  according to:

$$\begin{aligned}
 \hat{\dot{y}} = & (a_{11} + ha_{41})^{-1} [a_{per}^{lin} - (a_{12} + ha_{42} + V_x)\dot{\psi} - (a_{13} + ha_{43} - g)\theta \\
 & - (a_{14} + ha_{44})\dot{\theta} - (b_{\delta 1} + hb_{\delta 4})\delta - (b_{u1} + hb_{u4})M_t] \quad (17)
 \end{aligned}$$

where the terms  $a_{ij}$ ,  $b_{\delta i}$  and  $b_{ui}$  are coefficients of matrices  $A_m$ ,  $B_\delta$  and  $B_{M_t}$ , respectively, in (2).

*Proof:* Extracting the expression of  $\dot{y}$  and  $\ddot{\theta}$  in (2) and replacing them in the linear expression of  $a_{per}$  in (13) allows  $\dot{y}$  to be isolated as a function of the measured signals. See [11],[18] for a detailed proof.

### Remarks

The use of  $a_{per}$  rather than  $a_{per}^{lin}$  in (17) will give a better estimation. Thanks to what precedes, the structured  $H_2$  output feedback problem is easily recast as a state feedback one, easy to solve. The resulting control law derived from the optimal state feedback gain  $[K_x^{opt} \quad K_{x_e}^{opt} \quad K_{x_w}^{opt}]$  can easily be rewritten like (9). As  $K_x^{opt} = [K_{y_x}^{opt} \quad K_{\dot{\psi}_x}^{opt} \quad K_{\theta_x}^{opt} \quad K_{\dot{\theta}_x}^{opt}]$ , the command call is on the term  $K_{y_x} \dot{y}$ , in which  $\dot{y}$  may be replaced by (17). Controller  $K^{st}(s)$  is of first order, exploiting all the plant outputs available for feedback, the steering angle and its derivative as well as for feedforward. In [11], a low-pass filtered perceived acceleration ( $a_{per}$ ) was considered in place of  $a_{per}^I$ . Also, an unstable exogenous signals model (see (6), with e.g. one  $\alpha_i = 0$ ) was considered based on results in [24], [25] to overcome the fact that  $P(s)$  is non-stabilizable in that case.

## V. LPV CONTROLLER SYNTHESIS USING GAIN-SCHEDULING

### A. Design of the LPV Controller

In the previous section, the commands are computed considering a constant speed  $V$ . To obtain a high level of performance over all admissible speeds, it must be noted that matrices  $A$  and  $C$  in (2) and (14) are dependent on  $V$  and  $1/V$ . To design an LPV controller, some approaches attempt to

solve a generalized version of the standard  $H_{2,\infty}$  optimization to the case of LPV systems, *e.g.* as in [30] by exploiting the idea that multi-linear interval matrix inequalities may be ascertained by testing only the vertices of the linear matrix inequalities (LMI). Such an approach is attractive since it gives *a priori* guarantees for the closed-loop stability. Nevertheless, in the present application, it leads to conservative results as the design model is considered polytopic with arbitrary fast parameter variations. We propose here to proceed in a more traditional way, by gain-scheduling, and then verifying stability in spite of acceleration. The range of the control gains inferred by the range of speed  $V_i \in \Omega$ ,  $\Omega = [2, 3, \dots, 18] m.s^{-1}$  is examined first. The control gain  $K_{V_i}$  is computed for each speed  $V_i$  ( $i: 1 \rightarrow 17$ ), keeping the same weighting parameters  $Q$  and  $R_i$ ; the results show that the controller gains  $K_i$  vary approximately as:

$$K(V) = K_c + K_v V + K_{1/v} 1/V, \quad (18)$$

where  $K_c$  and  $K_v$  and  $K_{1/v}$  have constant values. The problem is then solved by interpolation as:

$$\underbrace{\begin{pmatrix} 1 & V_1 & 1/V_1 \\ 1 & V_2 & 1/V_2 \\ \dots & \dots & \dots \\ 1 & V_{17} & 1/V_{17} \end{pmatrix}}_M \underbrace{\begin{pmatrix} K_c \\ K_v \\ \dots \\ K_{1/v} \end{pmatrix}}_{K_v^{LTI}} = \begin{pmatrix} K_{V_1} \\ K_{V_2} \\ \dots \\ K_{V_{17}} \end{pmatrix} \Rightarrow \begin{pmatrix} K_c \\ K_v \\ K_{1/v} \end{pmatrix} = (M^T M)^{-1} M^T K_v^{LTI} \quad (19)$$

with  $[V_1, V_2, \dots, V_{17}] = [2, 3, \dots, 18]$ .

### B. A posteriori Robustness Analysis

The  $H_2$  norm of the closed-loop transfer function  $\|T_{zw}\|_2$  was evaluated, comparing results obtained with the LPV controller at the interpolation points,  $K(V_i)$ , and the original controllers  $K_{V_i}$  [11]. Although these results are good, they give no stability guarantee when the speed  $V$  varies with time. For this reason, we complete the analysis by using the results in [31]. Based on the transformation of any rational LPV state-space realization to an affine descriptor one to simplify the parametric dependency, the proposed algorithm enables the evaluation of a guaranteed  $H_2$  norm bound, using LMI formulation and semi-definite programming. This algorithm is appealing as it is based on a linear criterion under parameterized LMI constraints of finite dimensions, thus avoiding a gridding of the parametric space. Concretely, the results of [31] were used first to find a Lyapunov function depending on the longitudinal speed,  $V$ , guaranteeing the stability of the closed-loop  $T_{zw}$  for a given range of  $V$ , and, secondly, to compute an upper bound of the energy  $\|z\|_2$  considering an impulse  $w$  input.

## VI. RESULTS

### A. Tuning of LTI Controllers

Table 2. Tuning Parameter Values and Associated LTI Controllers

	$Q$	$R_1$	$R_2$
Controller D (DTC)	1	$10^4$	$10^{-6}$
Controller SD (SDTC)	1	$10^2$	$10^{-6}$
Controller S (STC)	1	1	$10^{-2}$

The weighting parameters  $Q_0 = \text{diag}(Q, R_1, R_2)$  in the standard model  $P(s)$  (8) make it possible to manage the compromise between a low solicitation of the inputs and a low deviation of the outputs to be regulated. They can also be used to privilege a DTC, an STC, or a combined DTC/STC strategy.

$$z = \left[ \sqrt{Q} a_{per}^T \quad \sqrt{R_1} \delta_c \quad \sqrt{R_2} M_t \right]^T. \quad (20)$$

In the sequel, parameter  $Q$  is normalized:  $Q = 1$ . Increasing  $R_1$  relative to  $R_2$  favors the DTC system, while the STC system is dominant if  $R_2$  is big relative to  $R_1$ . The proposed tunings studied in this paper are summed up in Table 2 and lead to three LTI Controllers: Controller D (DTC), Controller SD (SDTC), and Controller S (STC). The three controllers were designed for each value of  $V_i \in \Omega$ ,  $\Omega = [2, 3, \dots, 18] m/s$ . State-feedback gains obtained at  $V = 8 m/s$  are presented in Table 4. The practical gains (function of  $a_{per}$  and not  $\dot{y}$ ) have to be recomputed considering (17).

### B. Time Performances and Robustness of LTI Controllers

Performances are evaluated on the non-linear model (1), considering in this section the frozen value  $V = 8 m/s$ . The scenario is defined by the driver steering angle given in Fig. 5; the NTV starts turning at  $t = 2 s$  ( $\delta_{driv} = 0 rad$  to  $0.27 rad$ ), *i.e.* the trajectory is based on a short straight-line, next a transient state between  $t = 2 s$  and  $t = 9 s$ , and finally a constant radius ( $r \approx 23 m$ ) circular trajectory. This trajectory is quite difficult compared to the one proposed *e.g.* in [4] which considers a radius of 500 m, or in [10]. It can represent an NTV taking a medium-sized roundabout. Bear in mind, however, that the simulation was run without a driver model ensuring the trajectory tracking; consequently, having an STC action or not will modify the trajectory of the vehicle. This choice was made as no driver model for NTV is yet available in the literature, and to develop one is not a minor task (interaction with the tilting system).

Considering Fig. 5, it can be seen that controllers S and SD provide a counter-steering action (which is not the case for controller D). This transient change of the driver steering reduces the lateral acceleration, at the price of a slight change in the vehicle trajectory desired by the driver: see Fig. 7. Controller S (STC behavior) requires no action of the direct



torque  $M_t$  (see Fig. 6) but changes the desired trajectory significantly (Fig. 7). The study of the perceived lateral acceleration  $a_{per}$  reveals that all the controllers ensure a perfect regulation after the transient phase, during the circular trajectory, thanks to the integral action. Although the DTC solution leads to good performances, the use of the steering system (*cf.* controllers S and D) improves the performances dramatically; the lateral acceleration is decreased by 85% (maximum value  $0.3 \text{ m/s}^2$  for D and  $0.02 \text{ m/s}^2$  for SD), and the torque  $M_t$  is decreased by 60% ( $50 \text{ N.m}$  to  $20 \text{ N.m}$ ). The lateral acceleration is even more reduced by controller S, even though the deviation is the opposite of the one obtained by controllers D or SD.

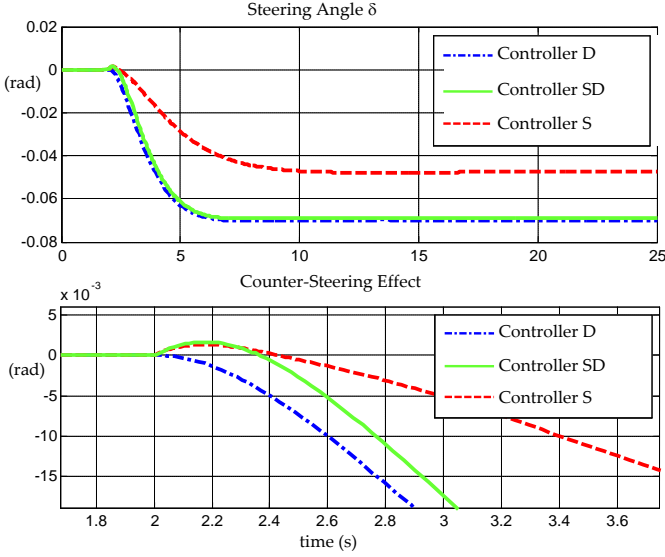

Fig. 5. Steering angle  $\delta = \delta_c + \delta_{dir}$

This result must be tempered because of the lack of a driver model, which makes the vehicle state trajectories different (see Fig. 8). To complete the analysis, Table 3 indicates the input multivariable modulus  $M_m$  and delay margins  $M_r$  [32].  $M_m$  is equal to 1 as the three controllers are optimal solutions of different  $H_2$ -LQ problems. The delay margins are quite good; that obtained with the SDTC controller is the best and the STC the lowest (but still acceptable). To conclude this analysis of the LTI controllers, the main result is that the multivariable action of STC and DTC can considerably improve performances of the NTV, without significantly changing the vehicle trajectory when compared to a DTC solution. One can expect the vehicle to remain quite easy to drive compared to an STC-based NTV, particularly at low speed.

Table 4. State-Feedback Gain Values of D, S, SD Controllers -  $V = 8 \text{ m/s}$

Controller		$K_{\dot{y}}$	$K_{\dot{\psi}}$	$K_{\theta}$	$K_{\dot{\theta}}$	$K_{a'_{per}}$	$K_{\delta}$	$K_{\dot{\delta}}$
D	$\delta_c$	-0.0049	0.0027	-0.0167	0.0039	0.0037	0.0709	0.0130
	$M_t$	$0.2335 \times 10^4$	$-0.1310 \times 10^4$	$0.8791 \times 10^4$	$0.2264 \times 10^4$	$-0.0928 \times 10^4$	$-3.6478 \times 10^4$	$-0.7148 \times 10^4$
SD	$\delta_c$	-0.1021	0.0544	-0.3352	-0.0792	0.0888	1.4318	0.2607
	$M_t$	$0.4040 \times 10^3$	$-0.2516 \times 10^3$	$2.1929 \times 10^3$	$0.7057 \times 10^3$	$0.4607 \times 10^3$	$-8.5839 \times 10^3$	$-2.0172 \times 10^3$
S	$\delta_c$	-0.1788	0.0394	-0.3595	-0.3784	0.2845	1.6733	0.3812
	$M_t$	0.0134	-0.0024	2.3751	15.5831	30.3163	-2.2191	-1.6348

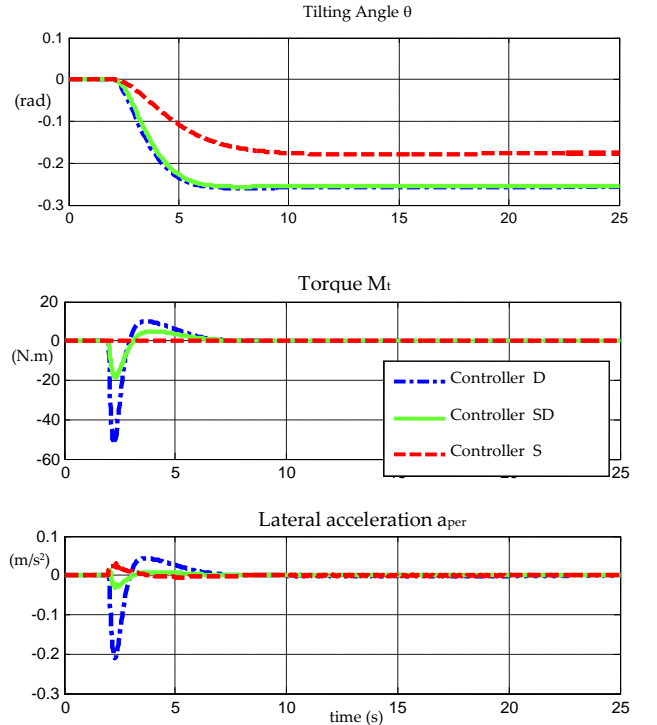

Fig. 6. Tilting angle, signal control  $M_r$ , and lateral acceleration,  $V = 8 \text{ m.s}^{-1}$

Table 3. Multivariable Stability Margins of Controllers D, SD, S

	$M_m$	$M_r$
Controller D (DTC)	1	+/- 0.102 s
Controller SD (SDTC)	1	+/- 0.147 s
Controller S (STC)	1	+/- 0.053 s

### C. Performance of Gain-Scheduled LPV Controllers

As mentioned in section V.B, the validity of the interpolated controller  $K(V)$  was verified first at each frozen value  $V = V_i$  whatever the controller S, D, SD considered. The  $H_2$ -norms of the closed-loop function  $T_{zw}$  considering  $K(V_i)$  or  $K_{V_i}$  have been computed and compared [11]. Next, the result in [31] was used to find a Lyapunov function depending on the longitudinal speed. One was found for controller D in the range  $[2, 18] \text{ m/s}$  but not for controllers SD and S. However, for these two, the stability was demonstrated in an overlapping range covering the whole range  $[2, 18] \text{ m/s}$  [11].

The time responses depicted in Fig. 9 were obtained with a

5DDL non-linear model based on (1) [11], considering the same scenario as before except for the longitudinal speed  $V$  which varies with time. The good performances of the LPV controller  $SD(V)$  in spite of the speed oscillations should be noted.

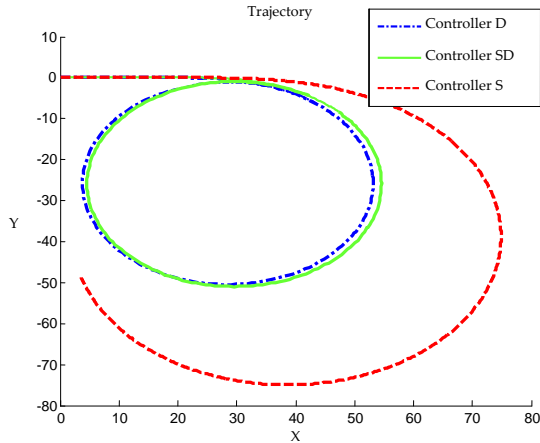

Fig. 7. Trajectories of the NTV considering the three controllers D, SD, S,  $V=8 \text{ m.s}^{-1}$

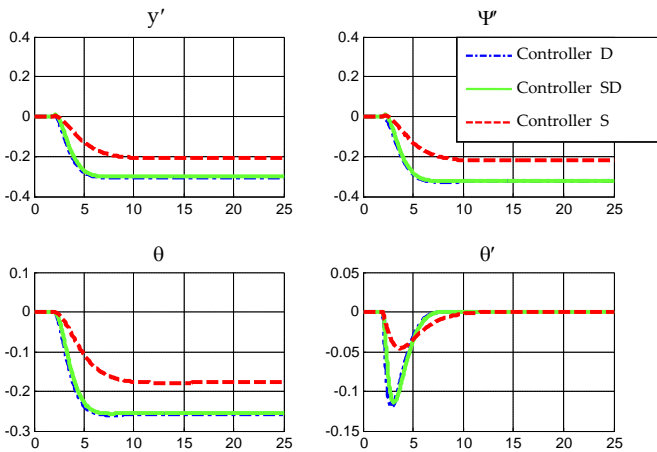

Fig. 8. States of the non-linear model of the NTV,  $V=8 \text{ m.s}^{-1}$

VII. CONCLUSION

After describing the state of the art of narrow tilting cars, both in the literature and in industry, we presented some simplified models, the one used here being based on the well known bicycle model. After listing the measurements easily available, the next stage was to formalize the control objectives. Contrary to what is commonly done, we regulated the perceived lateral acceleration directly rather than the tilting angle. The control objectives were then recast as an optimal structured  $H_2$  control problem, in a systematic way. The methodology proposed makes use of a second order model for the steering signal, which is new and realistic.

It leads to controllers with two degrees of freedom and an efficient feedforward exploiting both the steering angle and its derivative to anticipate. As the whole state cannot practically be measured for feedback, a static observer was included, which does not reduce the robustness margins. Another interest of the control methodology proposed is that it enables

different controllers with different levels of action on the direct tilting torque and the steering angle to be easily synthesized. By using appropriate weighting functions, the controller moves from purely DTC (Direct Tilt Control) to purely STC (Steering Tilt Control), going through all possible combinations. Finally, an LPV controller was designed which was shown to be robust during speed variation. In our opinion, this methodology will be useful both for solving the problem of future narrow vehicles proposed by manufacturers, and generically to appreciate the relative potential and limitations of DTC and STC systems.

Among future perspectives, it will be interesting to develop a realistic driver model [33] for such narrow tilting controlled vehicles, in order to appreciate its interaction with the DTC and STC systems considered. To the authors' knowledge, this is still a completely open and challenging problem. Finally, we hope to continue our collaboration with car manufacturers, proposing a dedicated model [17] and control.

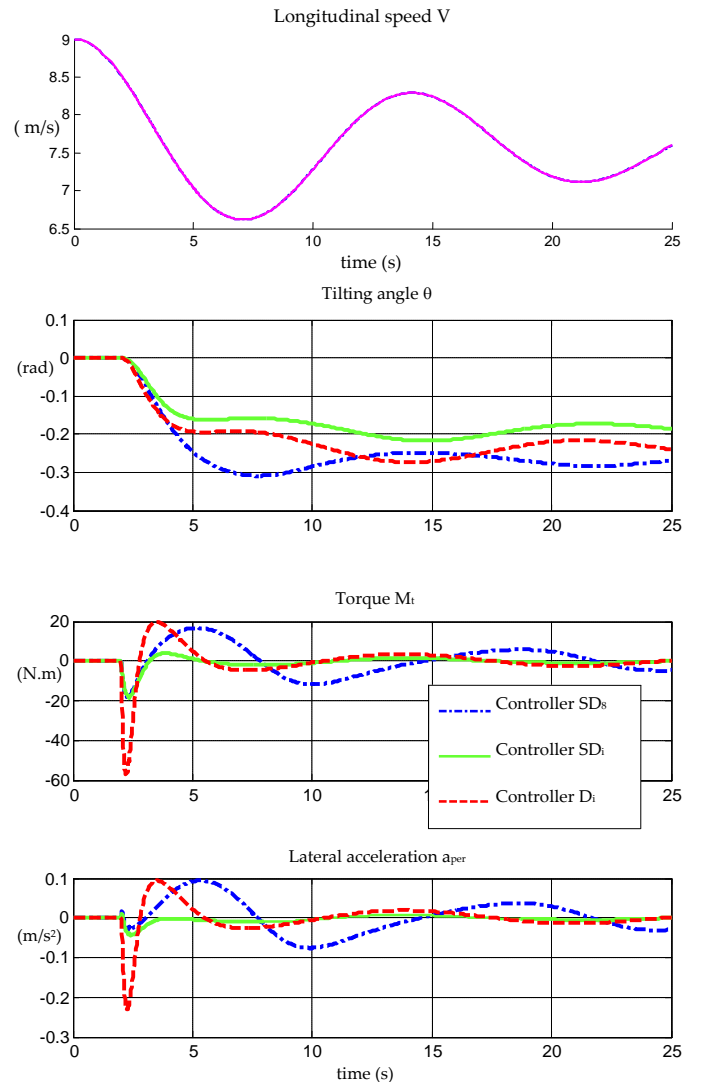

Fig. 9. Comparison between the LPV controller  $SDTC \text{ } SD(V)$ , the LPV controller  $DTC \text{ } D(V)$ , and the LTI controller  $SD_s \text{ } (V = 8 \text{ m.s}^{-1})$

## REFERENCES

- [1] Web site: <http://www.lumeneo.fr/>
- [2] R. Rajamani, J. Gohl, L. Alexander, and P. Starr, "Dynamics of narrow tilting vehicles". *Math. and Comp. Model. of Dyn. Sys.*, vol. 9, n°2, 2003, pp. 209-231.
- [3] R. Rajamani, *Vehicle Dynamics and Control*. Springer, US, 2006, Chapter 2.
- [4] D. Piyabongkarn, T. Keviczky, and R. Rajamani, "Active Direct Tilt Control for stability enhancement of a narrow commuter vehicle," *Intern. Journ. of Auto. Tech.*, vol. 5, n°2, 2004, pp. 77-88.
- [5] S.G. So and D. Karnopp, "Switching strategies for narrow ground vehicles with dual mode automatic tilt control," *Intern. Journ. of Veh. Des.*, vol. 18, n°2, 1997, pp. 518-532 (special issue).
- [6] S.G. So and D. Karnopp, "Active dual mode tilt control for narrow ground vehicles," *Vehicle System Dynamics*, vol. 27, 1997, pp. 19-36.
- [7] S. Kidane, L. Alexander, R. Rajamani, P. Starr, and M. Donath, "Road bank angle considerations in modeling and tilt stability controller design for narrow commuter vehicles," in *Proc. IEEE Amer. Contr. Conf.*, Minneapolis, USA, 2006.
- [8] S. Kidane, L. Alexander, R. Rajamani, P. Starr, and M. Donath "A fundamental investigation of tilt control systems for narrow commuter vehicles," *Vehicle System Dynamics*, vol. 46, 2008, pp. 295-322.
- [9] S. Kidane, L. Alexander, R. Rajamani, P. Starr, and M. Donath "Development and experimental evaluation of a tilt stability control system for narrow commuter vehicles," *IEEE Trans. on Contr. Sys. Tech.*, vol. 18, n°6, 2010, pp. 1266-1279.
- [10] R. Hibbard and D. Karnopp, "Twenty first century transportation system solutions- A new type of small, relatively tall and narrow active tilting commuter vehicle," *Vehicle System Dynamics*, vol. 25, 1996, pp. 321-347.
- [11] L. Mourad, "Active lateral acceleration control of a narrow tilting vehicle," Ph.D. Dissertation, Ecole des Mines de Nantes, Nantes, 2012 (in French). <http://hal.archives-ouvertes.fr/tel-00787310/>
- [12] J. Roberston, J. Darling, and A. Plummer, "Path following performance of narrow tilting vehicles equipped with active steering," in *Proc. 11th Conf. on Eng. Sys. Design and Ana.*, Nantes, France, 2012.
- [13] J.H. Berote, "Dynamics and control of a tilting three wheeled vehicle," Ph.D. Dissertation, University of Bath, UK, 2010.
- [14] N. Roquero, G. d.F. Marcelo, and F.C. Enric, "Sliding mode controller and flatness based set-point generator for a three wheeled narrow vehicle," in *Proc. 18th IFAC World Congress*, Milano, Italy, 2011.
- [15] J.C. Chiou and C.L. Chen, "Modeling and verification of a diamond shape narrow tilting vehicle," *IEEE/ASME Trans. on Mech.*, vol. 13, n°6, pp. 678-691, 2008.
- [16] S. Maakaroun, Ph. Chevrel, M. Gautier, and W. Khalil, "Modeling and Simulation of a Two wheeled vehicle with suspensions by using Robotic Formalism," in *Proc. 18th IFAC World Congress*, Milano, Italy, 2011.
- [17] S. Maakaroun, "Modeling and dynamic simulation of an original urban vehicle by using robotic formalism," Ph.D. Dissertation, Ecole des Mines de Nantes, Nantes, 2011.
- [18] L. Mourad, F. Claveau, and Ph. Chevrel, "A lateral control strategy for narrow tilting commuter vehicle based on the perceived lateral acceleration," in *Proc. 18th IFAC World Congress*, Milano, Italy, 2011.
- [19] L. Mourad, F. Claveau, and Ph. Chevrel, "Commande multivariable STC/DTC pour la stabilité latérale de véhicules étroits et inclinables," in *Proc. Conf. Intern. Franco. d'Auto.*, Grenoble, France, 2012 (in French).
- [20] L. Mourad, F. Claveau, and Ph. Chevrel, "Design of a two DOF gain scheduled frequency shaped LQ controller for Narrow Tilting Vehicles," in *Proc. IEEE Amer. Contr. Conf.*, Montreal, Canada, 2012.
- [21] K. Zhou, J. Doyle, and K. Glover, *Robust and optimal control*, Prentice Hall, 1996.
- [22] Ph. De Larminat, *Standard control methodology (Contrôle d'état standard)*. In Collection pédagogique d'automatique. Paris: Hermès Science Publications, 2000 (in French).
- [23] E.J. Davison, and A. Goldenberg, "Robust control of a general servomechanism problem: the servo compensator," *Automatica*, vol. 11, 1975, pp. 461-471.
- [24] Ph. Chevrel,  $H_2$  multivariable control methodology (Méthodologie de la commande par l'approche d'état). In *Automatique Linéaire*. IC2, Sous la direction de Ph. De Larminat. Paris, France: Hermès, 2002, pp. 151-192.
- [25] M. Yagoubi, Ph. Chevrel, and F. Claveau, "An extended state-feedback  $H_2$  controller for descriptor systems," in *Proc. 3rd Ifac Symp. on Sys., Struct. and Contr.*, Iguassu Falls, Brazil, 2007.
- [26] K. Liu, H. Zhang, and T. Mita, "Solution to nonsingular  $H_2$  optimal control problem with unstable weights," *Systems and Control Letters*, vol. 32, 1997, pp. 1-10.
- [27] P. Apkarian, D. Noll, and A. Rondepierre, "Mixed  $H_2/H_\infty$  control via nonsmooth optimization," *SIAM, Journ. on Contr. and Opt.*, vol. 47, n°3, 2008, pp. 1516-1548.
- [28] J.V. Burke, D. Henrion, A.S. Lewis, and M.L. Overton, "HIFOO – a MATLAB package for fixed-order controller design and  $H_\infty$  optimization," in *Proc. IFAC Symp. on Rob. Contr. Des.*, 2006.
- [29] D. Arzelier, G. Deaconu, S. Gumussoy, and D. Henrion, " $H_2$  for HIFOO," in *Proc. International Conference on Control and Optimization with Industrial Applications*, Ankara, Turkey, 2011 <http://www.cs.nyu.edu/overton/software/hifoo/>.
- [30] P. Apkarian, P. Gahinet, and G. Beker "Self-scheduled  $H_\infty$  control of linear parameter varying system: A design example," *Automatica*, vol. 31, 1995, pp. 1251-1261.
- [31] A. Bouali, M. Yagoubi, and P. Chevrel, " $H_2$  gain scheduling control for rational LPV systems via a descriptor framework," in *Proc. 47th Conference on Decision and Control*, Cancun Mexico, 2008.
- [32] Y. Huang and K. Zhou, "Robust control of uncertain time delay systems," in *Proc. of IEEE Conference on Decision and Control*, Phoenix, USA, 1999.
- [33] L. Saleh, Ph. Chevrel, F. Claveau, J.F. Lafay, and F. Mars, "Shared steering control between a driver and an automation: stability in the presence of driver behaviour uncertainty," *IEEE Trans. on Intel. Transp. Sys.*, vol. 14, n°2, 2013, pp. 974-983. doi : [10.1109/TITS.2013.2248363](https://doi.org/10.1109/TITS.2013.2248363)



**L. Mourad** gained a Dipl.-Ing. degree from the Lebanese University, Faculty of Engineering II, Lebanon, as well as a Master's degree in Automatic Control from the University of Nantes – Ecole Centrale de Nantes, Nantes, France, in 2008. In 2012, she gained a Ph.D. in Automatic Control from the University of Nantes – Ecole des Mines de Nantes, Nantes, France. The field of application of her Ph.D. work is automotive engineering, especially narrow tilting vehicles. Since 2013, she has held the position of Instrumentation and

Control Engineer, and works on the control system of nuclear reactors.



**F. Claveau** gained a Dipl.-Ing. degree from the Ecole Nationale Supérieure d'Ingénieurs de Bourges, Bourges, France, in 2001, and a Ph.D. in Automatic Control from the University of Nantes – Ecole Centrale de Nantes, Nantes, France, in 2005. Since 2005, he has been an Assistant Professor at the Ecole des Mines de Nantes, France, and also a member of the Control Team of the Institute of Communications and Cybernetics of Nantes (IRCCyN – UMR CNRS 6597).

His research interests are focused on robust control, decentralized and distributed control design methodologies. His main field of application is automotive engineering, especially the design of driving assistances for conventional or more specialized (e.g. narrow tilting) vehicles. F. Claveau is member of two Research Group of the CNRS, MOSAR (multivariable robust control), GTAA (automotive control).

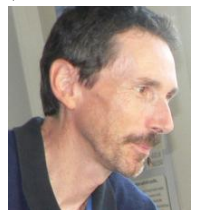

**P. Chevrel** gained a Ph.D. from the University of Paris XI, in 1993. He is currently a Professor at the Ecole des Mines de Nantes, supervising the whole teaching activity in control, quality and logistics from 2004 to 2012. He is also a member of the control team at IRCCyN (IRCCyN – UMR CNRS 6597), where he is co-responsible of the control team.

His main research interests are in robust control theory, active control and decentralized control. He is also involved in control methodology, leading to the development of CAD algorithms for control design and implementation. He wrote on these topics more than 100 journal and conference papers, and book chapters. He has been working on different applications in automotive control and robotics, active control, electrical engineering, etc. He is coauthor of several patents and of numerous contract reports. Pr. Chevrel is member of two Research Group of the CNRS, MOSAR (multivariable robust control), GTAA (automotive control), and also member of the EEA and IEEE control society.